



SY8008A/B/C

High Efficiency 1.5MHz, 0.6A/1A/1.2A Synchronous Step Down Regulator

General Description

The SY8008A, SY8008B and SY8008C are high-efficiency 1.5MHz synchronous step-down DC-DC regulator ICs capable of delivering up to 1.2A output currents. The SY8008 family operate over a wide input voltage range from 2.5V to 5.5V and integrate main switch and synchronous switch with very low $R_{DS(ON)}$ to minimize the conduction loss.

Low output voltage ripple and small external inductor and capacitor sizes are achieved with 1.5MHz switching frequency. This along with small SOT-23/TSOT-23 footprint provides small PCB area application.

Ordering Information

SY8008□(□□)□

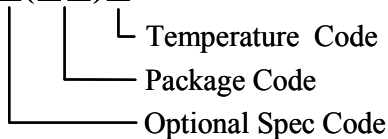

Temperature Range: -40°C to 85°C

Ordering Number	Package type	Note
SY8008AAAC	SOT23-5	0.6A
SY8008BAAC	SOT23-5	1A
SY8008CAAC	SOT23-5	1.2A
SY8008AACC	TSOT23-5	0.6A
SY8008BACC	TSOT23-5	1A

Features

- Low $R_{DS(ON)}$ for internal switches (top/bottom)
 - SY8008A: 300mΩ /250mΩ, 0.6A
 - SY8008B: 250mΩ /200mΩ, 1A
 - SY8008C: 200mΩ /150mΩ, 1.2A
- 2.5-5.5V input voltage range
- 1.5MHz switching frequency minimizes the external components
- Internal softstart limits the inrush current
- 100% dropout operation
- RoHS Compliant and Halogen Free
- Compact package: SOT23-5/ TSOT23-5 pin

Applications

- Portable Navigation Device
- Smart phone
- USB Dongle
- Set Top Box
- Media Player

Typical Applications

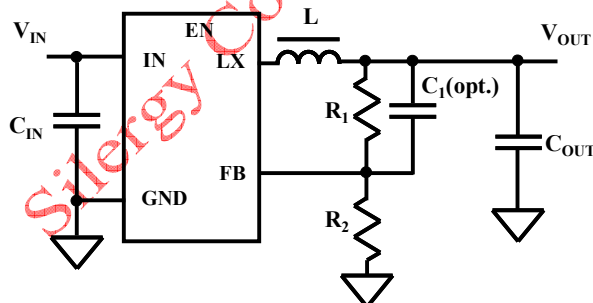

Figure 1. Schematic Diagram

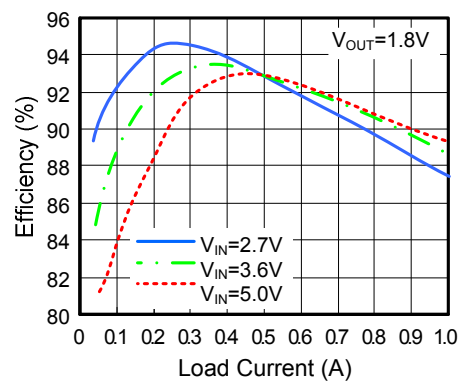
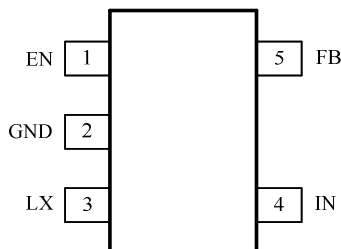

Figure 2. Efficiency vs Load Current (SY8008B)

Pinout (top view)



(SOT23-5, TSOT23-5)

Part Number	Package type	Top Mark ^①
SY8008AAAC	SOT23-5	AAxyz
SY8008BAAC	SOT23-5	ABxyz
SY8008CAAC	SOT23-5	ACxyz
SY8008AACC	TSOT23-5	Blxyz
SY8008BACC	TSOT23-5	BGxyz

Note ①: x=year code, y=week code, z=lot number code.

Pin Name	Pin Number	Pin Description
EN	1	Enable control. Pull high to turn on. Do not float.
GND	2	Ground pin.
LX	3	Inductor pin. Connect this pin to the switching node of the inductor.
IN	4	Input pin. Decouple this pin to the GND pin with at least 1uF ceramic capacitor.
FB	5	Output Feedback Pin. Connect this pin to the center point of the output resistor divider (as shown in Figure 1) to program the output voltage: $V_{OUT}=0.6*(1+R_1/R_2)$. Add optional C_1 (10pF~47pF) to speed up the transient response.

Absolute Maximum Ratings (Note 1)

Supply Input Voltage	6.0V
Enable, FB Voltage	$V_{IN} + 0.6V$
Power Dissipation, P_D @ $T_A = 25^\circ C$, SOT23-5, TSOT23-5	0.6W
Package Thermal Resistance (Note 2)	
SOT23-5, TSOT23-5, θ_{JA}	170°C/W
SOT23-5, TSOT23-5, θ_{JC}	130°C/W
Junction Temperature Range	125°C
Lead Temperature (Soldering, 10 sec.)	260°C
Storage Temperature Range	-65°C to 150°C
ESD Susceptibility (Note 2)	
HBM (Human Body Mode)	2kV
MM (Machine Mode)	200V

Recommended Operating Conditions (Note 3)

Supply Input Voltage	2.5V to 5.5V
Junction Temperature Range	-40°C to 125°C
Ambient Temperature Range	-40°C to 85°C



Electrical Characteristics

($V_{IN} = 5V$, $V_{OUT} = 2.5V$, $L = 2.2\mu H$, $C_{OUT} = 10\mu F$, $T_A = 25^\circ C$, $I_{MAX} = 1A$ unless otherwise specified)

Parameter	Symbol	Test Conditions	Min	Typ	Max	Unit
Input Voltage Range	V_{IN}		2.5		5.5	V
Shutdown Current	I_{SHDN}	EN=0		0.1	1	μA
Feedback Reference Voltage	V_{REF}		0.588	0.6	0.612	V
FB Input Current	I_{FB}	$V_{FB} = V_{IN}$	-50		50	nA
PFET R_{ON}	$R_{DS(ON)P}$	SY8008A		300		m Ω
		SY8008B		250		m Ω
		SY8008C		200		m Ω
NFET R_{ON}	$R_{DS(ON)N}$	SY8008A		250		m Ω
		SY8008B		200		m Ω
		SY8008C		150		m Ω
PFET Current Limit	I_{LIM}	SY8008A	0.8			A
		SY8008B	1.2			A
		SY8008C	1.5			A
EN Rising Threshold	V_{ENH}		1.5			V
EN Falling Threshold	V_{ENL}				0.4	V
Input UVLO Threshold	V_{UVLO}				2.5	V
UVLO Hysteresis	V_{HYS}			0.1		V
Oscillator Frequency	F_{OSC}	$I_{OUT} = 100mA$		1.5		MHz
Min ON Time				50		ns
Max Duty Cycle			100			%
Thermal Shutdown Temperature	T_{SD}			160		$^\circ C$

Note 1: Stresses listed as the above “Absolute Maximum Ratings” may cause permanent damage to the device. These are for stress ratings. Functional operation of the device at these or any other conditions beyond those indicated in the operational sections of the specifications is not implied. Exposure to absolute maximum rating conditions for extended periods may remain possibility to affect device reliability.

Note 2: θ_{JA} is measured in the natural convection at $T_A = 25^\circ C$ on a low effective single layer thermal conductivity test board of JEDEC 51-3 thermal measurement standard. Pin 2 of SOT23-5/TSOT23-5 packages is the case position for θ_{JC} measurement. Test condition: Device mounted on 2” x 2” FR-4 substrate PCB, 2oz copper, with minimum recommended pad on top layer and thermal vias to bottom layer ground plane

Note 3: The device is not guaranteed to function outside its operating conditions.

SOT23-5 Package outline & PCB layout design

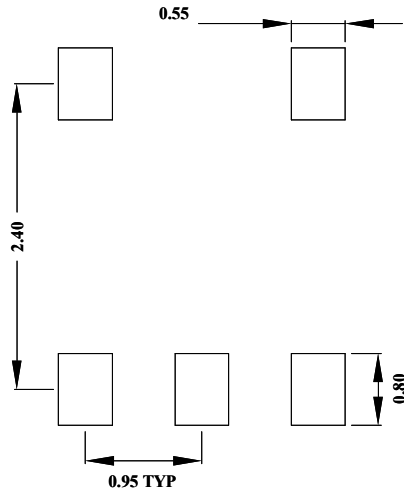

Recommended Pad Layout

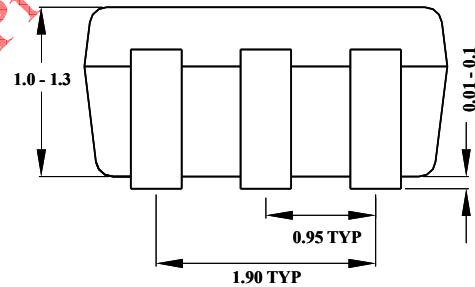
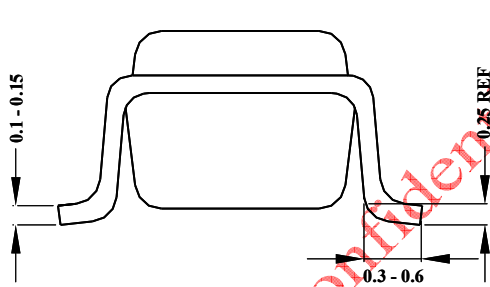
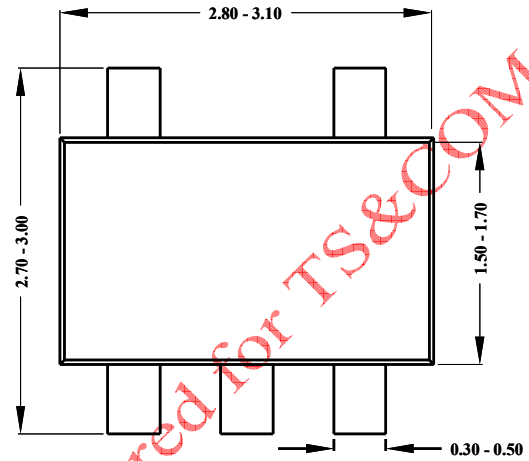

Notes: All dimensions are in millimeters.
All dimensions don't include mold flash & metal burr.

TSOT23-5 Package outline & PCB layout design

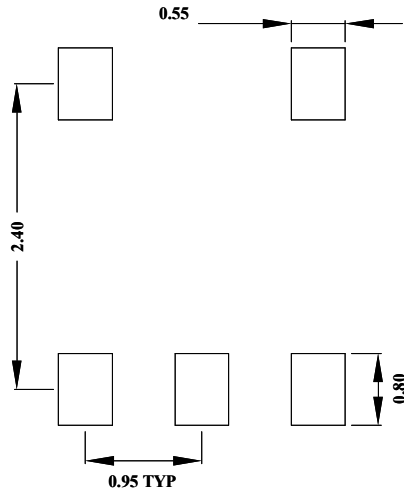

Recommended Pad Layout

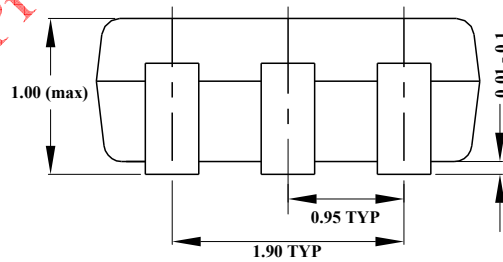
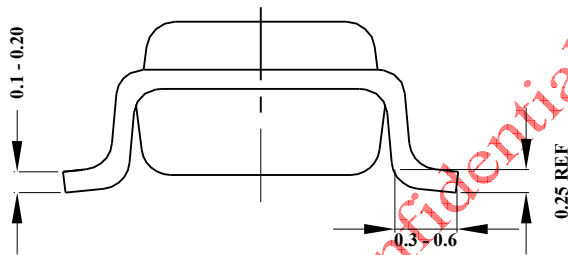
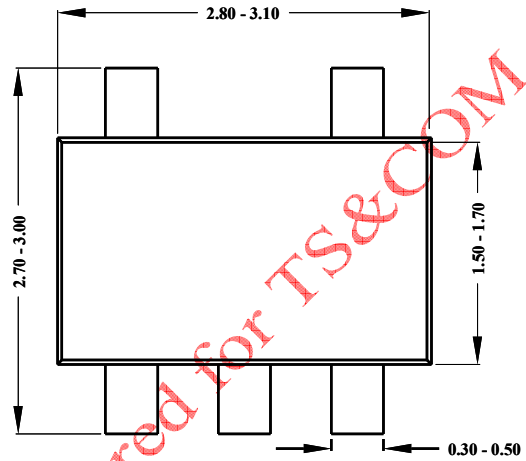

Notes: All dimensions are in millimeters.
 All dimensions don't include mold flash & metal burr.